

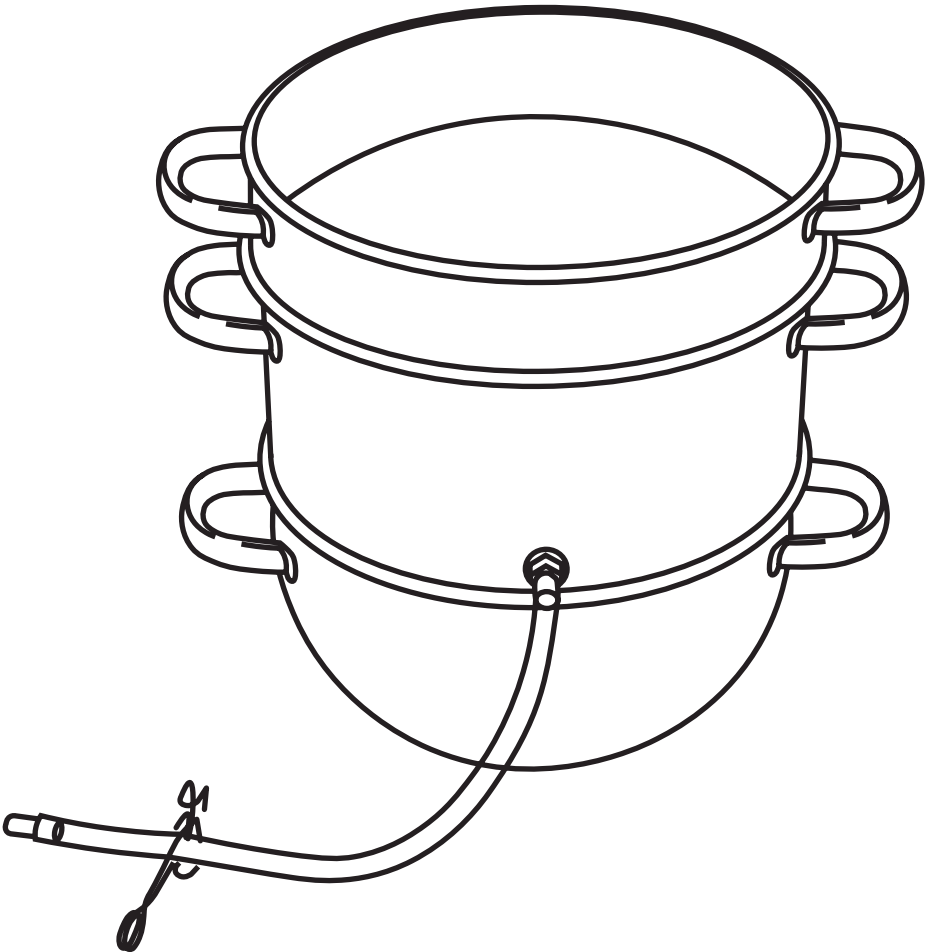

---

# LITTLE CREEK™ WATER DISTILLER

## Instruction Manual



## Table of Contents

Parts Diagram .....	3
Operating Precautions.....	4
Instructions & Warnings.....	4
Care Instructions.....	4
Multiple Uses .....	5
Overview .....	5
Assembly & Use Instructions .....	6
Distiller Assembly & Use.....	6
Product Warranty .....	8

\*For the most up-to-date manual, or for more information regarding this product, visit our website: **VKPbrands.com**

# Little Creek Water Distiller

## Model VKP1208

### Parts Diagram

Your complete Water Distiller includes everything shown below:

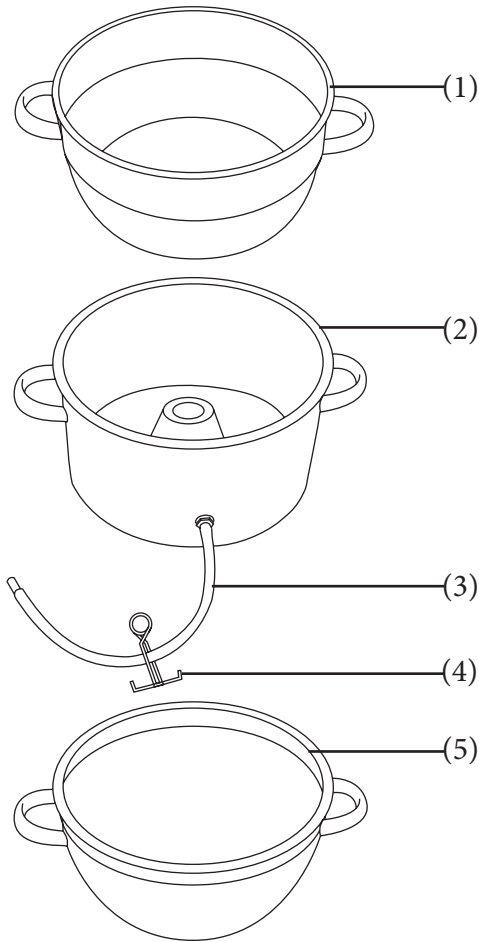

### Parts List

- (1) VKP1208-2 Condenser Pan
- (2) VKP1140-3 Collector Pan
- (3) VKP1140-6 Hose with Metal Tip
- (4) VKP1140-5 Spring Clamp
- (5) VKP1140-10 Water Pan

All replacement parts are available on our website, [VKPbrands.com](http://VKPbrands.com).

## Operating Precautions

**TO PREVENT PERSONAL INJURY AND TO PREVENT DAMAGE TO YOUR WATER DISTILLER, PLEASE READ AND FOLLOW ALL OF THE FOLLOWING**

### INSTRUCTIONS & WARNINGS

- Always use heat protective gloves or mitts when handling any part of your distiller.
- Any steam produced will be hot and can cause a serious burn injury. Use extreme caution while using your distiller.
- Check the water pan water level often. **Do not let the water pan boil dry.** This will cause serious damage and warping to your distiller and may render it unusable. Your stovetop could also be damaged if this happens.
- Never leave your water distiller unattended while in use.
- Do not use by or near children.
- For household use only.

### Care Instructions

Before first use, wash all parts of the distiller in the dishwasher or by hand with warm soapy water. This will help to remove any particles or residue from the factory. Once clean, dry everything with a soft dish towel to keep water spots from forming.

- Before first use, fill the collector pan with water to test the hose. If water does not freely flow, turn the metal tubing inside the pan slightly to one side.
- As you use the distiller, minerals will be left behind inside the water pan and condenser pan. This is normal and it is recommended that these deposits be cleaned out to ensure optimal performance of your distiller. They are easily cleaned by soaking the affected portion in a diluted vinegar solution. Use ½ c. vinegar to 1 qt. of water, let soak for 30-60 minutes, use a dish cloth to wash off any remaining hard water, rinse and dry. You may need to increase the soak time and/or the amount of vinegar used for tough stains.

## Multiple Uses

Although the primary purpose of this item is to distill water, the parts that make up this distiller can be used in a variety of ways.

- Double Boiler - Remove the collector pan and use only the water pan and condenser pan and it can be used as a double boiler.
- Ice Bath - Fill the bottom pan with ice and place the condenser pan on top and you have an ice bath.
- Stock Pot - The water pan can also be used as a stock pot
- Stainless Steel Bowls - Both the condenser pan and water pan can be used as stainless steel bowls.
- Render animal fat into lard/tallow - Place ground fat inside condenser pan and use as a double boiler or use with collector pan to distill water at the same time you render the fat.
- Steam Juicer - Just replace the condenser pan with the colander and add the lid and this can also be used as a steam juicer. The lid and colander are available on our website [VKPbrands.com](http://VKPbrands.com)

VKP1140-1 - Lid

VKP1140-2 - Colander

## Overview

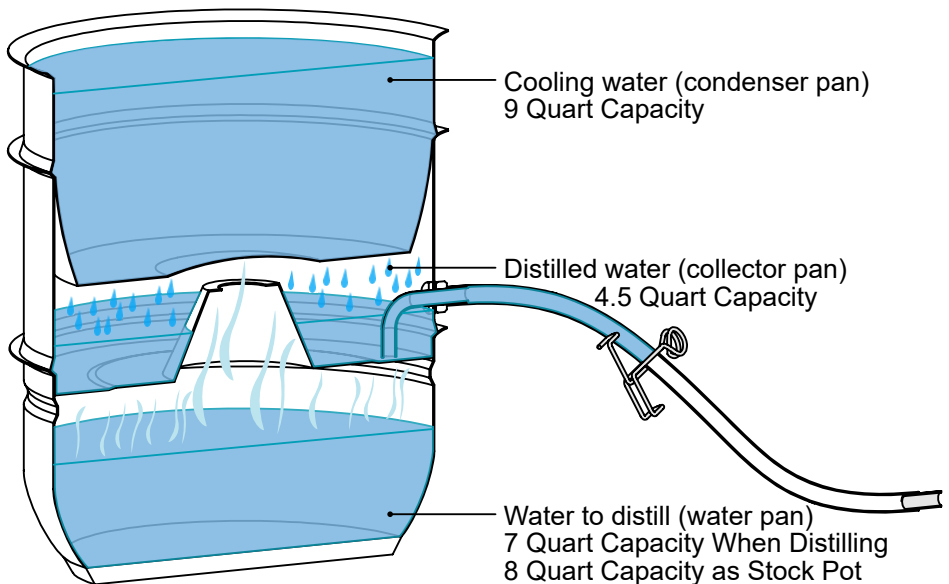

## Assembly & Use Instructions

Make sure you have read through the sections - **Operating Precautions (p. 4)** and **Care Instructions** listed above - before assembling and using your distiller.

### Distiller Assembly & Use

1. Remove your new Water Distiller from the box and packaging and check that all items are included and in good condition. Refer to the diagram on p. 3 for a list of all parts.

2. Wash all parts of the distiller thoroughly by hand, including the hose and clamp, in warm soapy water, and rinse carefully.

3. Once clean, take the water pan and fill it with water up to the line and place it on your stove-top. (See diagram at right)

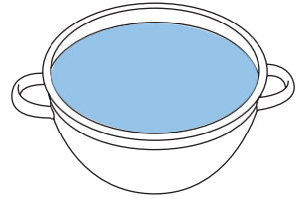

4. Next, place the collector pan on top of the water pan. Squeeze the clamp and slide it to the center of the hose. (See diagram at right)

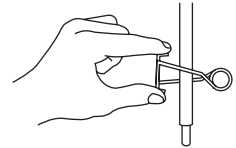

5. Fill the condenser pan all the way to the top with water and place on top of the collector pan. (See diagram at right)

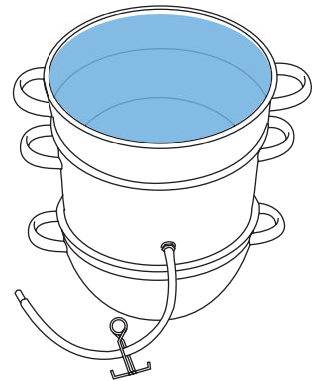

7. Do NOT place a lid or anything else on top of the condenser pan and do NOT put ice or ice water in the condenser pan. The water in the condenser will get hot and you will see steam evaporate. This is an indicator that the distiller is working properly. For best performance, top off the water in the condenser pan every few hours to keep it full.

8. After correctly assembling your distiller, turn on the burner unit to the High position. **Be sure to always use heat protective gloves or mitts while working with your distiller. The steam is very hot and will burn you.**

9. Once the water has come to a rapid boil, begin turning down your burner temperature until the water remains at a consistent rolling boil that is not too vigorous.
10. Do not let the water pan boil dry, or damage to the water pan or your stovetop may occur. By placing 2-3 marbles in the water pan you can hear when the water is almost out. It is recommended that the first time you use the distiller, or any time it is used on a different stove, you note how long it takes for the water pan to almost run out of water and record that time. Then each time you use the distiller, you can set an alarm to notify you when the water pan is almost boiled dry.
11. You will need a container ready for the distilled water to drain into. Metal or glass containers work best, as the water will be near boiling temperature. Place it slightly below the distiller so the hose hangs down into the container by 3-4 inches. (See diagram at right). It will take about 1-2 hours before there is enough water in the collector to drain.
12. Once the distiller is up to temperature, it should distill about one quart of water per hour; however, this will vary depending upon the stove or heat source that is used. If your distiller is spitting water or has large amounts of steam escaping between where the pans fit together, this is an indicator that your heat is too high. Gradually lower the heat until this problem stops.
13. If after following all of these instructions you are still having trouble please contact us at 866-257-4741 or [Help@VKPbrands.com](mailto:Help@VKPbrands.com). We are happy to work with you and correct any problems you are having.

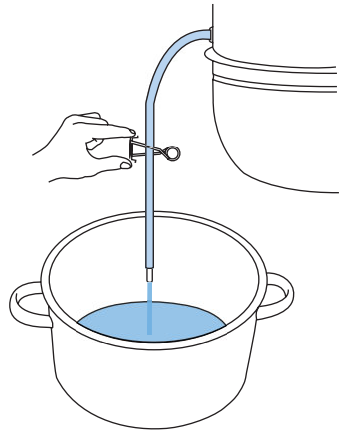

## **Product Warranty**

Register your warranty online at:  
**VKPbrands.com/Warranty**

Model VKP1208 - Little Creek Water Distiller: 5 years

We are confident in the quality of our products and back each one with a limited warranty for the length of time specified above. Should you experience any problems with your product, please contact our Customer Service Department.

All warranty claims must be accompanied by a proof of purchase and are only valid if the appliance has been operated within the U.S. or Canada and used for its intended purposes. These products are for household use only.

### **Items Not Covered:**

- Return shipping costs or returned items lost in transit.
- Damages to the product due to accident, misuse, abuse, negligence, or if the appliance has been altered in any way.
- Products used outside of the United States or Canada.

# Kitchen Crop™

1804 Sandhill Rd

Orem UT, 84058

Phone: **866-257-4741**

**VKPbrands.com**