



JOHNNY APPLE PEELER[®]

SUCTION BASE

Instruction Manual



Table of Contents

Parts Diagram	3
Warning.....	4
Assembly	4
Mounting to a suitable surface.....	5
Align, adjust, and secure blades	5
Align the coring/slicing blade.....	5
Test alignment	6
Adjust peeling blade.....	6
Adjust peeling arm.....	7
Place apple on fork	7
To peel, slice, and core	8
Peeling only	8
Slicing and coring without peeling	8
Cleaning and care	9
Tips and tricks	9
Dehydrating Apples	9
Making Shoestring Potatoes	10
Troubleshooting Guide	11
Product Warranty	12

*For the most up-to-date manual, or for more information regarding this product, visit our website: **VKPbrands.com**

Johnny Apple Peeler (Suction Base) Model VKP1010

Parts Diagram

Your complete Johnny Apple Peeler includes everything shown below:

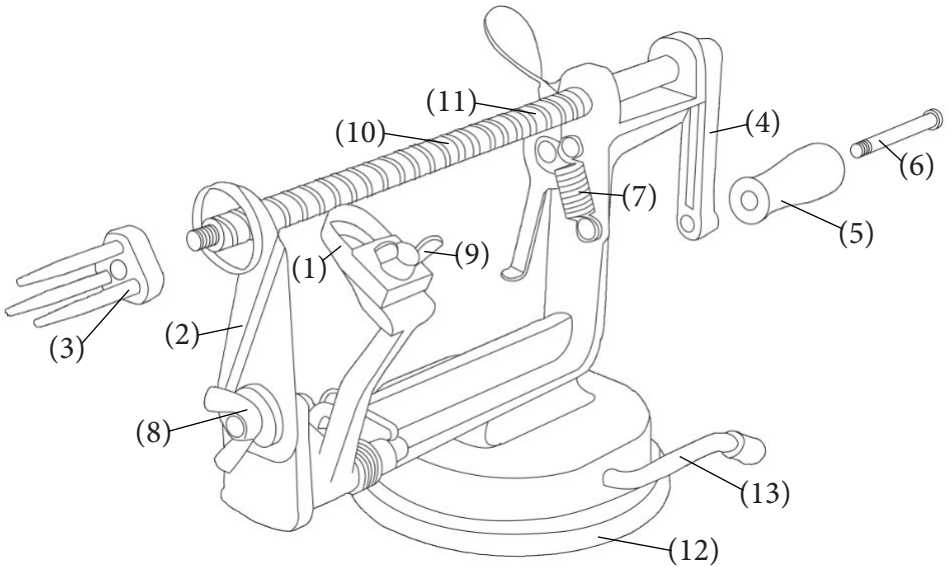

Parts List

- (1) VKP1010-1 Peeling Blade
- (2) VKP1010-2 Coring & Slicing Blade
- (3) VKP1010-3 Fork
- (4) VKP1010-5 Handle Arm
- (5) VKP1010-6 Wooden Handle Grip
- (6) VKP1010-7 Handle Screw
- (7) VKP1010-8 Lever Spring
- (8) VKP1010-9 Wing Nut for Coring Blade
- (9) VKP1010-10 Wing Nut for Peeling Blade
- (10) VKP1010-11 Standard Drive Shaft - 1/4" Slices
- (11) VKP1010-12 Thin Slice Drive Shaft - 3/16" Slices (Optional, Not Included)
- (12) VKP1010-13 Base & Clip
- (13) VKP1010-16 Suction Lever & Rubber Tip

All replacement parts are available on our website, VKPbrands.com.

Congratulations!

You now own the world's finest apple and potato peeler, the Johnny Apple Peeler. It's designed to save you time, effort, and money by performing several tasks at once. Before plunging right in and peeling a bushel of apples or a bag of potatoes, you will want to get acquainted with your peeler. With the turn of the handle you can do the following:

- Peel apples or potatoes
- Peel, core, and slice apples
- Core and slice apples without peeling
- Make shoestring potatoes

Warning

- Peeler has sharp blades and edges that can cause serious injury if used or handled improperly.
- Use caution at all times when cleaning, assembling, adjusting, or using this peeler.
- Close supervision is required when peeler is used by children.
- For household use only. Warranty void for commercial use.
- Please read the entire manual before using.

Assembly

1. Using a Phillips screwdriver, attach the handle to the handle arm with the handle screw.
2. Attach the fork to the end of the driveshaft.

Video

Please visit our website to view "Assembling the Apple Peeler" video: VKPbrands.com/Videos

Thin Slice Drive Shaft

Get the optional Thin Slice Drive Shaft for thinner 3/16" slices (VKP1010-12 Sold separately) VKPbrands.com/Store

Mounting to a suitable surface

Before using, the peeler needs to be properly secured to a suitable surface so it will stay firmly in place during use. Otherwise, the peeler will not work properly.

Suction Base: The suction mount must be used with a smooth and non-porous surface. When the suction cup is used on the correct mounting surface it will stay firmly in place and allow the peeler to be used without need to reattach. Surfaces that may not be suitable are wood, small or rough tile, granite, textured surfaces, or surfaces with cracks.

Align, adjust, and secure blades

Each time before using the peeler, it is critical that the blades are properly aligned, adjusted, and secured. Misaligned or unsecured blades will damage the peeler. This video shows how to properly align, adjust, and secure the blades:

“Assembling the Apple Peeler” video: VKPbrands.com/Videos

Align the coring/slicing blade

The fork should be able to pass through the center of the blade without touching the sides. The correct alignment is shown to the right. The blade **MUST** be tightened firmly so it will not move out of alignment during operation. *Use caution when adjusting, the blade is sharp!

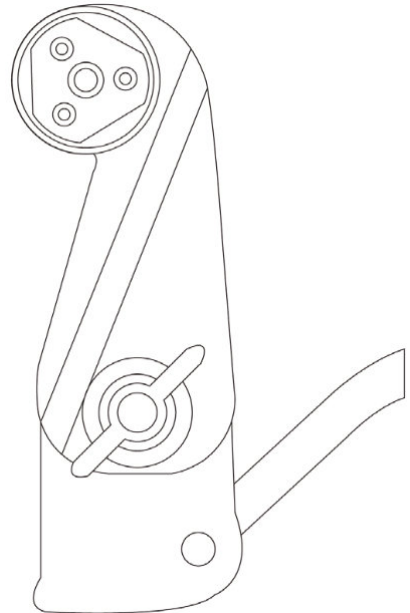

Test alignment

Test alignment by pressing down on the thumb lever. While holding the thumb lever down, move the driveshaft forward and backward. Watch the fork as it is passing through the center of the coring/slicing blade. Observe carefully to make sure the fork doesn't touch the sides of the coring blade.

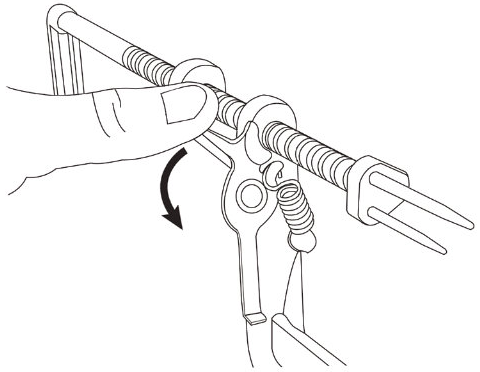

***Misalignment of the coring/slicing blade is the most common user mistake which will result in damage to the blade and possibly the fork.**

Adjust peeling blade

The peeling blade works best when adjusted to about 1/8 inch past the head of the peeling arm. To adjust the peeling blade, loosen the wing-nut 1/2 turn. The blade can be moved forward to remove more peel, or backward to remove less peel. Firmly tighten the wing-nut after the adjustment has been made. It may require a few tests and further blade adjustment before you get the desired result. ***Use caution when adjusting, the blade is sharp!**

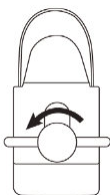

Loosen

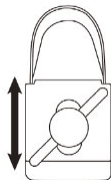

Adjust

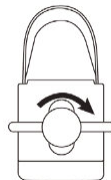

Tighten

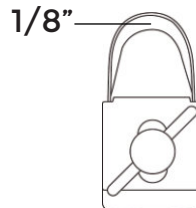

Adjust peeling arm

The peeling arm has been factory adjusted to have approximately 1/4 inch clearance between the peeling blade and the widest part of the fork. To adjust the position of the peeling arm, either tighten or loosen the adjustable screw to achieve proper spacing. Turn the screw clockwise to adjust it away from the fork. Turn the screw counter-clockwise to adjust it closer to the fork.

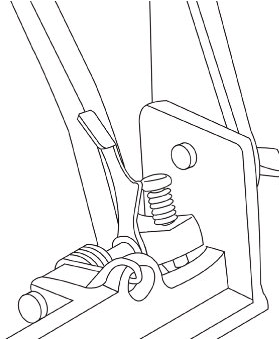

Place apple on fork

Press the thumb lever (see illustration on top of page 6), and pull the driveshaft away from the coring/slicing blade. Pull until the fork is as far away from the coring/slicing blade as possible. Center apple stem end first in front of the fork. Press apple firmly onto the fork. Turn the handle clockwise a few turns to make sure the apple is centered on the fork properly. Adjust if necessary. The illustration below shows how the apple should be placed on the fork when you are ready to begin peeling.

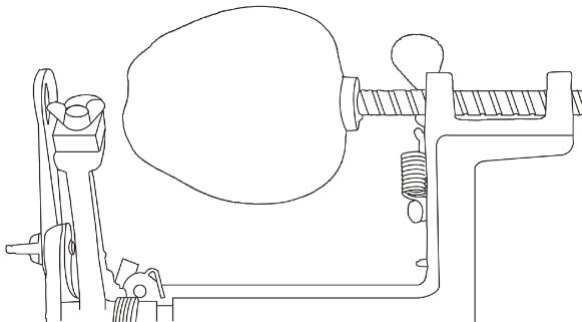

To peel, slice, and core

To peel, turn the handle slowly clockwise to advance the apple into the blades. The peeling blade will automatically adjust to the contour of the apple as it advances forward. To remove the core, push down the thumb lever and pull back on the handle. The core will be ejected by the coring/slicing blade. After the core has been ejected, pull the driveshaft back to the starting position to work on the next apple.

Peeling only

- Peeling apples and potatoes is quick and easy with the Johnny Apple Peeler.
- Loosen the wing-nut that holds the coring/slicing blade in place. Remove the blade or simply turn it out of the path of the apple or potato.
- Center your apple or potato on the fork.
- Turn the handle slowly clockwise to advance the produce past the peeling blade.
- Carefully remove the produce from the fork.

Slicing and coring without peeling

Used when peel is preferred on the fruit for color, flavor, or texture.

- Pull the peeling arm downward and engage the lock lever. The lock lever will keep the peeling blade clear of the fruit.

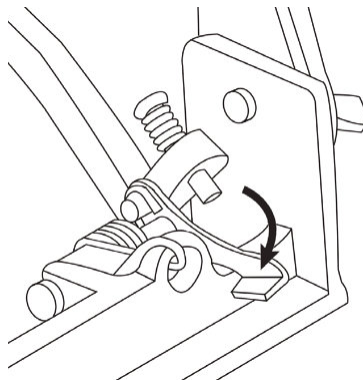

Cleaning and care

- When cleaning the entire unit, hand washing is recommended.
- After washing, dry all parts thoroughly by hand. Do not allow to air dry.
- Peeling and coring/slicing blades can be washed in a dishwasher.
- A drop of vegetable oil on the moving parts will insure smooth operation for next use.

Tips and tricks

- When the coring/slicing of the apple is finished, the apple looks like a spring. Use a paring knife to slice down one side of the apple for uniform rings. Use a paring knife to slice down opposite sides of the apple for uniform slices.
- Apples and potatoes that are firm, blemish free, and uniform in shape work best. For best results, use small and medium sized apples. Very large apples may have undesirable results.
- US Grade #1 potatoes will yield the best results.
- Avoid using soft fruit. Soft fruit will have problems peeling and staying in place on the fork. Freshly picked apples are less likely to be soft or mealy inside, making them a great choice.
- If no suitable mounting surface is available for the suction base model, attach to a clean cookie sheet or glass baking dish. This will provide a smooth and non-porous surface while also containing the juice and waste for easy cleanup.
- If no suitable mounting surface is available for the clamp base model, consider a collapsible wooden tray table. Make sure the edge is squared and not beveled.

Dehydrating Apples

1. Dehydrating apples not only allows you to preserve apples for future use, but to make a nutritious, sweet snack. With your Johnny Apple Peeler the most difficult step will be deciding which type of apple to use.
2. Choose firm, unblemished apples.
3. In a bowl, mix two quarts of cool water with one cup of lemon juice. This mixture will be used for dipping the slices to prevent the apples from browning.

4. Slice/core/peel apples (peeling the apples is optional). Using a paring knife, slice down opposite sides of the apple to make uniform slices.
5. Place slices in the water mixture until all apples have been sliced.
6. Lay slices evenly, without touching one another, on the trays of your food dehydrator. Optional: Sprinkle slices with cinnamon.
7. Allow apples to dehydrate until approximately 20% moisture remains. The slices will remain pliable, but will not be sticky.
8. Enjoy!

Making Shoestring Potatoes

The first step to restaurant-style hash browns is cutting them to shoestring thickness. No more scrubbing potatoes and knuckles across the graters. The Johnny Apple Peeler makes cutting shoestring potatoes nearly effortless.

1. Remove the coring/slicing blade from the path of the shaft.
2. Adjust the peeling blade as far toward the potato as possible so that it cuts deep into the potato.
3. Turn the handle and peel the potato with a deep cut.
4. When the full length of the potato has been peeled, lock back the peeling arm, pull back the driveshaft, and then release the peeling arm.
5. Repeat steps 3 and 4 until the peeling blade will no longer clear the 3-prong fork.
6. Fry until crisp.
7. Enjoy!

TROUBLESHOOTING GUIDE

PROBLEM	SOLUTION
Peeler is taking off too much flesh with the peel.	Adjust the peeling blade to remove less flesh with the peel. See page 6 for instructions.
Peeling blade is digging in/gouging fruit when first starting to peel.	Peeling arm and/or peeling blade needs to be adjusted. See page 6 and page 7 for instructions.
Peeling blade and peeling arm have been adjusted, but peeling blade is still digging in/gouging fruit when first starting to peel.	Use only firm fresh apples. If the apple is soft or the peel is wrinkly the blade will dig into the fruit. Carefully check peeling blade for sharpness. If blade is damaged or dull, contact customer service.
Apples do not stay in place on fork when peeling.	Use only firm fresh apples and make sure it is pressed completely onto the fork. If the core of the apple is too soft it will break apart and fall off. See page 7 for more details.
Does not peel all sides of produce evenly.	Produce is not centered on fork properly or is not symmetrical.
Fork won't pass through center of coring/slicing blade.	Coring/slicing blade is out of alignment or has been damaged (bent or out of round). See page 5 for alignment instructions. If damaged, contact Customer Service.
Suction base doesn't attach or comes loose during use.	<p>Surface is not smooth AND non-porous. A surface may feel smooth, but is still a porous surface. Granite, for example, may feel smooth, but is a porous surface. Use a surface which is both smooth and non-porous.</p> <p>If you have been processing a lot of juicy apples, you may need to clean up some of the juice. Clean and dry the work surface. Clean and dry the suction base. Reattach the peeler to the surface.</p>

Product Warranty

Register your warranty online at:
VKPbrands.com/Warranty

Model VKP1010 - Johnny Apple Peeler (Suction Base): 5 years

We are confident in the quality of our products and back each one with a limited warranty for the length of time specified above. Should you experience any problems with your product, please contact our Customer Service Department.

All warranty claims must be accompanied by a proof of purchase and are only valid if the appliance has been operated within the U.S. or Canada and used for its intended purposes. These products are for household use only.

Items Not Covered:

- Return shipping costs or returned items lost in transit.
- Damages to the product due to accident, misuse, abuse, negligence, or if the appliance has been altered in any way.
- Products used outside of the United States or Canada.

VKP™

B R A N D S

1804 Sandhill Rd

Orem UT, 84058

Phone: **866-257-4741**

VKPbrands.com

Johnny Apple Peeler is a trademark of VKP Brands
© Copyright 2022 VKP Brands, all rights reserved